

HOT WATER TEMPERATURE MAINTENANCE

Providing the comfort of instant hot water is the key requirement of any modern hot water system. The Raychem single-pipe system keeps water at the right temperature in a building's water distribution pipe work. The intelligent system first keeps the investment cost low and then it operates economically and efficiently.

AN HYGIENIC SYSTEM

Less water volume and less heat loss in the pipe work help prevent bacteriological problems.

A FLEXIBLE AND SPACE-SAVING SYSTEM

The space requirement for pipes has been reduced because there are no return pipes. Risers, shafts and openings can be optimised freeing space for other services.

LOW INVESTMENT COSTS

The heating cable is simply fixed on the supply pipe. There is no need for return pipe work, valves or pumps, nor for complex design and balancing work associated with return systems.

LOWER POWER CONSUMPTION

The heat loss in the system is significantly lower as only the heat loss from the feed pipe (and not from the return pipe) is to be compensated for. There is also no power requirement for circulation pumps.

The single-pipe system can be used with a smaller boiler and as there is no cold return water coming into the boiler, the heat-up of the water is more efficient.

The intelligent HWAT-ECO control unit saves power e.g. it can lower the temperature or switch off during water consumption peaks.

NO MAINTENANCE COSTS

The system has no mechanical parts such as a recirculation pump or control valves. There are no parts to wear out.

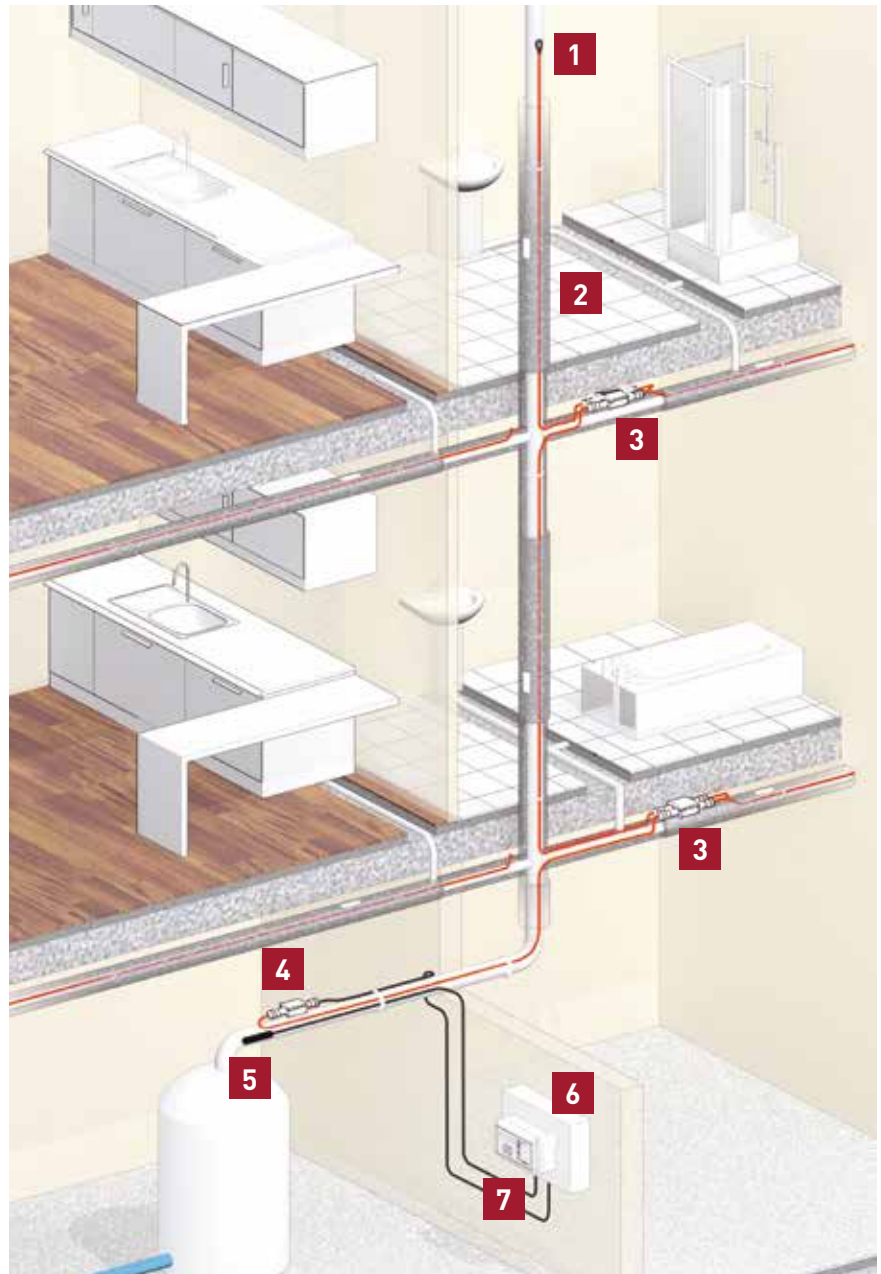

1 Gel-filled end seal (RayClic-E-02)

2 Heating cable (HWAT-L, M or R)

3 4-way connection (RayClic-X-02)

4 Power connection (RayClic-CE-02)

5 Sensor HWAT-ECO (incl.)
A three-wire PT-100 temperature sensor (HARD-78) can be installed optionally in an immersion pipe installed on site.

6 Residual current device (rcd) (30 mA) Circuit-breaker (C type)

7 Temperature control unit (HWAT-ECO)



1 HEATING CABLE SELECTION

Optimum water temperature maintenance for single family houses, flats, offices, hotels, hospitals, convalescent homes, sports centres, ...

Heating cable type	HWAT-L	HWAT-M	HWAT-R
Power output	7W/m at 45°C	9 W/m at 55°C	12 W/m at 70°C
Max. exposure temperature	65°C	65°C	80°C
Outer jacket colour	yellow	orange	red
Control unit HWAT-ECO 	-	recommended for enhanced energy - efficiency	essential
Legionella preventio			Possibility of thermal legionella prevention up to the draw-off points

2 COMPOSITION OF THE HWAT-L/M/R HEATING CABLE

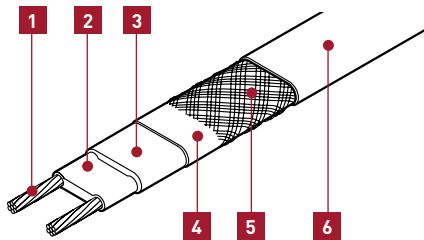

- 1 Copper conductor (1.2 mm²)
- 2 Self-regulating heating element
- 3 Modified polyolefin insulation
- 4 Aluminium foil wrap
- 5 Protective tinned copper braid
- 6 Modified polyolefin protective outer jacket.

Technical data: see page 61

3 HEATING CABLE LENGTH

The heating cable is installed in a straight line on the pipework
The heating cable can be traced right up to the draw-off points

Total length of pipe to be traced
+ approx. 0.3 m per connection
+ approx. 1.0 m per T-connection
+ approx. 1.2 m per 4-way connection
= required heating cable length

4 INSULATION THICKNESSES

Pipe size (mm)	15	22	28	35	42	54
Insulation thickness (mm)	20	20	25	30	40	50

Ambient temperature: 18°C

Thermal conductivity $\lambda = 0.035 \text{ W/(m.K)}$

For other thermal conductivity insulation materials, contact your Pentair Thermal Management representative.

Thermal losses in W/m, pipe 55°C in 18°C ambient temp.

Insulation	DN 15	DN 20	DN 32	DN 40	DN 50
15 mm	10	12	16	18	21
20 mm	9	10	14	15	18
30 mm	7	8	11	12	14
40 mm	6	7	9	10	12
50 mm	6	7	8	9	10
60 mm	5	6	8	8	9

HOT WATER TEMPERATURE MAINTENANCE

Thermal losses in W/m, pipe 55°C in 5°C ambient temp.

Insulation	DN 15	DN 20	DN 32	DN 40	DN 50
15 mm	13	16	21	24	28
20 mm	12	13	18	20	23
30 mm	10	11	14	16	18
40 mm	8	10	12	13	15
50 mm	8	9	11	12	13
60 mm	7	8	10	11	12

Calculations with TraceCalc PRO

- Maintain temperature 55°C
- Building interior
- Safety factor 10%
- Mineral wool, thermal conductivity at 40°C 0.041 W/mk

5 ELECTRICAL PROTECTION

- The total length of heating cable determines the number and size of the circuit breakers
- Residual current device (rcd): 30 mA required
- Power cabling for the heating cables according to local regulations
- The power connection must be carried out by an approved electrical installer

Circuit-breaker to BSEN 60898 (type C): the maximum length of the heating circuit is based on a minimum start-up temperature of +12°C, 230 VAC.

	HWAT-L	HWAT-M	HWAT-R
10 A	80 m	50 m	50 m
13 A	110 m	65 m	65 m
16 A	140 m	80 m	80 m
20 A	180 m	100 m	100 m

6 CHECKLIST FOR PLANNING THE INSTALLATION

The system design should take into account:

- Pipe diameter and material
- Insulation type and thickness
- Ambient temperature
- Circuits should divide the plumbing into logical segments
- Don't exceed the maximum circuit length
- Show connection locations on the drawings
- Locate power connections near the electrical panel
- Locate T-connections in accessible areas

7 TESTING OF THE INSTALLATION See page 58

8 CONTROL PANELS

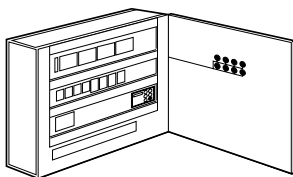

Control Panel: Steel plate housing, wall-mounted version, equipped with mains power switch, RCD/CB combination, inlet and outlet terminals. Completely assembled, turnkey condition wired and inspected cable guides in base of housing. The control panel contains a HWAT-ECO temperature control.

SBS-01-HM-ECO-10

Control panel for heating circuit, basic version.

- PCN: 390056-000

SBS-03-HV-ECO-10

Control panel for 2 to 3 heating circuits.

- PCN: 035958-000

SBS-06-HV-ECO-10

Control panel for 4 to 6 heating circuits.

- PCN: 539268-000

SBS-09-HV-ECO-10

Control panel for 7 to 9 heating circuits.

- PCN: 294452-000

9 CONTROL UNITS

HWAT-ECO

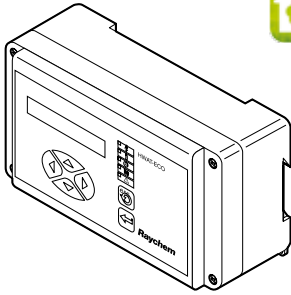

Electronic temperature control unit with integrated clock

- Building-specific programme
- Boiler temperature monitoring
- Economy programmes
- Password protection
- Simple user interface
- Compatible with HWAT-L/M/R heating cables
- BMS interface
- Alarm outputs

Technical data: see page 12

HARD-78

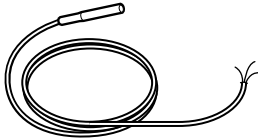

PT-100 temperature sensor (HARD-78) for assembly in sensor pipe installed on site.

- Diameter of sensor cable 4 mm
- Diameter of sensor element 6 mm
- Length of sensor element 50 mm
- Sensor length total 3 m

10 ACCESSORIES

RayClic-CE-02

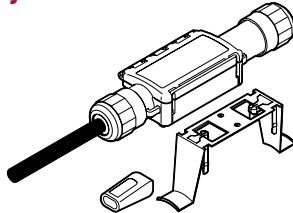

Power connection

- With 1.5 m power cable
- End seal and support bracket
- IP 68
- External dimension: L = 240 mm
W = 64 mm
H = 47 mm

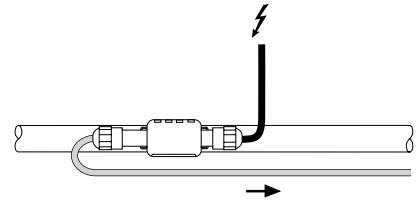

RayClic-T-02

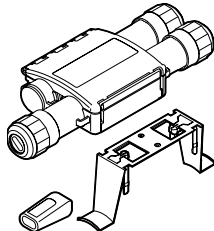

T-connection

- Connection for 3 cables
- End seal and support bracket
- IP 68
- External dimension: L = 270 mm
W = 105 mm
H = 42 mm

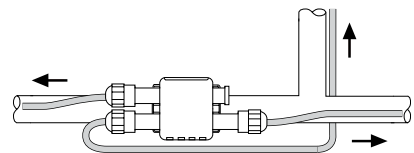

RayClic-PT-02

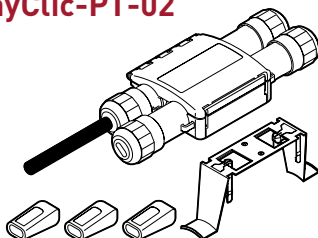

Power T-connection

- 3 connections with integral 1.5 m power cable
- 3 end seals and 1 support bracket
- IP 68
- External dimension: L = 270 mm
W = 105 mm
H = 42mm

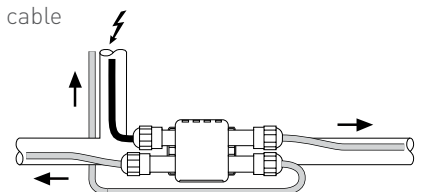

HOT WATER TEMPERATURE MAINTENANCE

RayClic-S-02

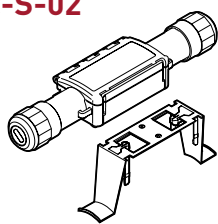

Splice for joining 2 lengths of heating cable

- Connection for 2 cables with 1 support bracket
- IP 68
- External dimension: L = 240 mm
W = 64 mm
H = 47 mm

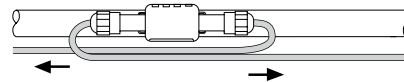

RayClic-PS-02

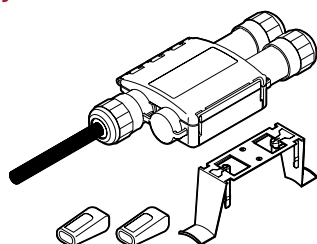

Powered splice

- Connection for 2 cables with integral 1.5 m power cable
- 2 end seals and 1 support bracket
- IP 68
- External dimension: L = 270 mm
W = 105 mm
H = 42 mm

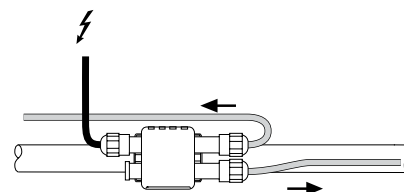

RayClic-X-02

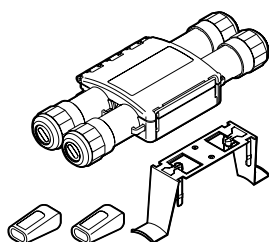

4-way connection

- Connection for 4 cables
- 2 end seals and 1 support bracket
- IP 68
- External dimension: L = 270 mm
W = 105 mm
H = 42 mm

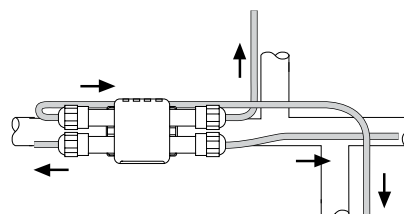

RayClic-E-02

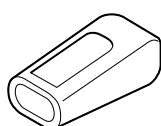

Gel-filled end seal

- For system extensions (to be ordered separately)
- IP 68



KBL-10

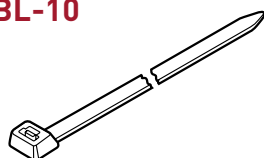

Cable ties

- One pack of 100 required for approx. 30 m of pipework
- Length: 370 mm
- Temperature and UV resistant

Use ATE-180 on plastic pipes

GT-66

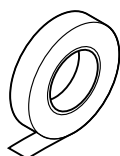

Heat-resistant glass cloth tape

- For steel pipes or for any installation below 4.4°C
- 20 m roll for approx. 20 m of pipework

Use ATE-180 on plastic pipes

GS-54



Glass cloth tape for attaching heating cable to pipe

- For stainless-steel pipes or for any installation below 4.4°C
- 16 m per roll, 12 mm width

ATE-180

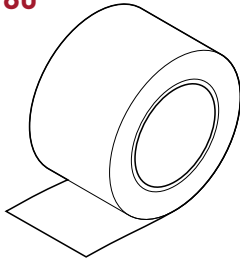

Aluminium adhesive tape

- Heat resistant up to 150°C
- 55 m roll for approx. 50 m of pipework

On plastic pipes: the heating cable must be covered with aluminium adhesive tape along its entire length

IEK-20-M (for HWAT-L, -M) / IEK-25-04 (for HWAT-R)

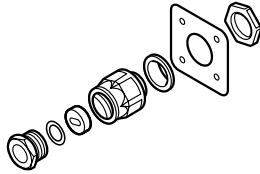

Insulation entry kit

- Insertion of heating cable in metal cladding
- Consists of: metal fasteners, metric gland and joint seal

LAB-I-01



Electric traced label

- To be placed at 5 m intervals on insulation surface

11 GENERAL INSTALLATION INSTRUCTION See page 61

Cabinet type unit			SBS-01-HM-ECO-10	SBS-03-HV-ECO-10	SBS-06-HV-ECO-10	SBS-09-HV-ECO-10
Number of heating circuits			1	3	6	9
Enclosure version			Wall version	Wall version	Wall version	Wall version
Dimensions	Width	mm	380	380	600	600
	Height	mm	600	600	600	600
	Depth	mm	210	210	210	210
Weight (ready to dispatch)	approx.	kg	21	22	32	33
Connected rating		kW	4,5	14	28	42
Customer fuse protection	max.	A	1 x 25A NH-00	3 x 32A NH-00	3 x 40A NH-00	3 x 63A NH-00

Enclosure Features						
Mains isolator switch, 3-pin, 25 A	Unit		1	1		
Mains isolator switch, 3-pin, 32 A	Unit		1			
Mains isolator switch, 3-pin, 63 A	Unit			1	1	
Line protection switch, S 2A	Unit		1	1	1	1
Transformer 230/24 VAC	Unit		1	1	1	1
Combination of RCD / Circuit breaker, C 20A, 30 mA, 4-pin with auxiliary switch	Unit		1*	1	2	3
Power contactor 3 x 35°	Unit			1	2	3
Auxiliary contactor	Unit		1	2	2	2
`Operating` indicator	Unit		1	1	2	3
`Fault` indicator	Unit		1	1	1	1
HWAT-ECO Control	Unit		1	1	1	1
Programmable logic module	Unit		-	-	1	1

* 2-pin

HWAT-ECO TEMPERATURE CONTROL UNIT



MODULE LAYOUT

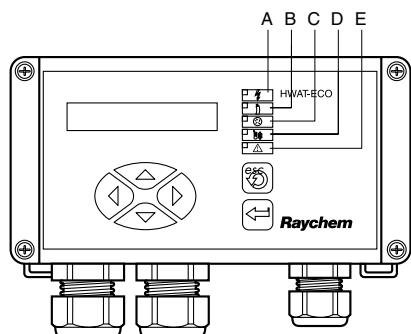

- A** Power supply on (green LED)
- B** Power to heater on (green LED)
- C** Legionella prevention (green LED) - heating cable 100% powered - increased risk of scalding
- D** Maintain temperature lowered following boiler temperature decrease (green LED) - boiler temperature is lower than expected.
- E** Error (red LED)



Change menu selection or position cursor



Escape, backspace or NO



Confirm selection, new value or YES

TECHNICAL DATA

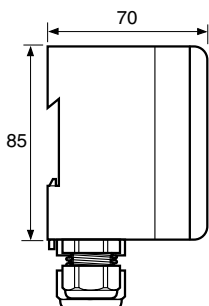
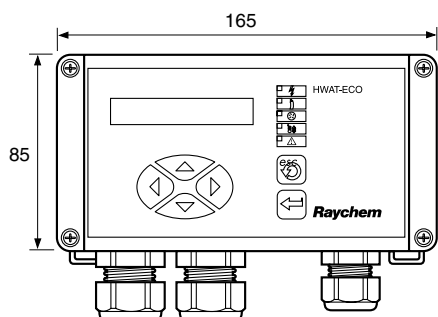

(Dimensions in mm)

Product description	HWAT-ECO
Use	Only for HWAT-L/M/R heating cables
Selectable maintain temperature	37°C to 65°C in max. 48 timer blocs per day
Operating voltage	230 VAC (+10%, -10%), 50 Hz
Switching capacity	20 A / AC 230V
Internal power consumption	2,5 VA
Circuit breaker	Max. 20 A, C-Characteristic
Power cable section entry	1.5 - 4 mm ² for fixed wiring only
Auxiliary cable section entry	Up to 16 AWG (1.3 mm ²)
Weight	880 g
Mounting options	Wall mount with 2 screws or DIN rail
Cable glands (entries)	2 x M20 and 1 x PG13.5 with 3 inputs for external wires of 3-5 mm
Protection level	IP 54
Ambient temperature	0°C to 40°C
Housing material	ABS
Internal temperature alarm	85°C
Master/slave cable	2-wire twisted pair shielded, max. 1.3 mm ² core and insulation of 500 V
Master/Slave	Master is selectable in the unit, up to 8 slaves can be connected
BMS interface	0 - 10 VDC
Alarm relay contacts	Max. 24VDC or 24 VAC, 1 A, SPDT voltage free
Boiler temperature sensor	PTC KTY 81-210 or PT 100 2-wire
Power correction factor	60% to 140% (fine tuning of maintained temperature)
Clock back-up time	Min. 1 year with lithium battery CR2025 (3V)
Clock accuracy	±10 minutes per year
Real time clock	Automatic summer/winter time and leap year correction
Parameters stored in non-volatile	All parameters, except date and time memory
Approval	VDE according to EN 60730
EMC	According to EN 50081-1/2 for emission and EN 50082-1/2 for immunity

Raychem requires the use of a 30 mA residual current device and a C-Characteristic circuit breaker to provide maximum safety and protection from fire. The unit complies with IEC1000-3-3 (flicker) if installed according to part 3 of VDE 0838. To avoid flicker install the unit in such a way that at the current value of the systems start-up temperature (max. 20 A per heating circuit) the voltage drop does not exceed 1% at the power supply of the lighting apparatus (normally subpanel).

PROGRAMME

The HWAT-ECO has 7 different building specific time/temperature programmes. These programmes are based on our long experience for optimum comfort and energy saving. For user specific changes in the programming, the Edit timer programme can be used.

Programme name	Building type
Programme 0	Constant temperature ($\pm 55^{\circ}\text{C}$)
Programme 1	Apartment block
Programme 2	Prison / Barracks
Programme 3	Hospital
Programme 4	Hotel
Programme 5	Sports centre / Swimming pool
Programme 6	Office

In addition, user specific programmes can be created

Temperature can be varied in 1/2 h blocks to any desired temperature between: OFF, economy t° , maintain t° and legionella prevention (100% powered, increased risk of scalding)

WIRING DIAGRAM FOR HWAT-L / HWAT-M / HWAT-R WITH HWAT-ECO TEMPERATURE CONTROL UNIT

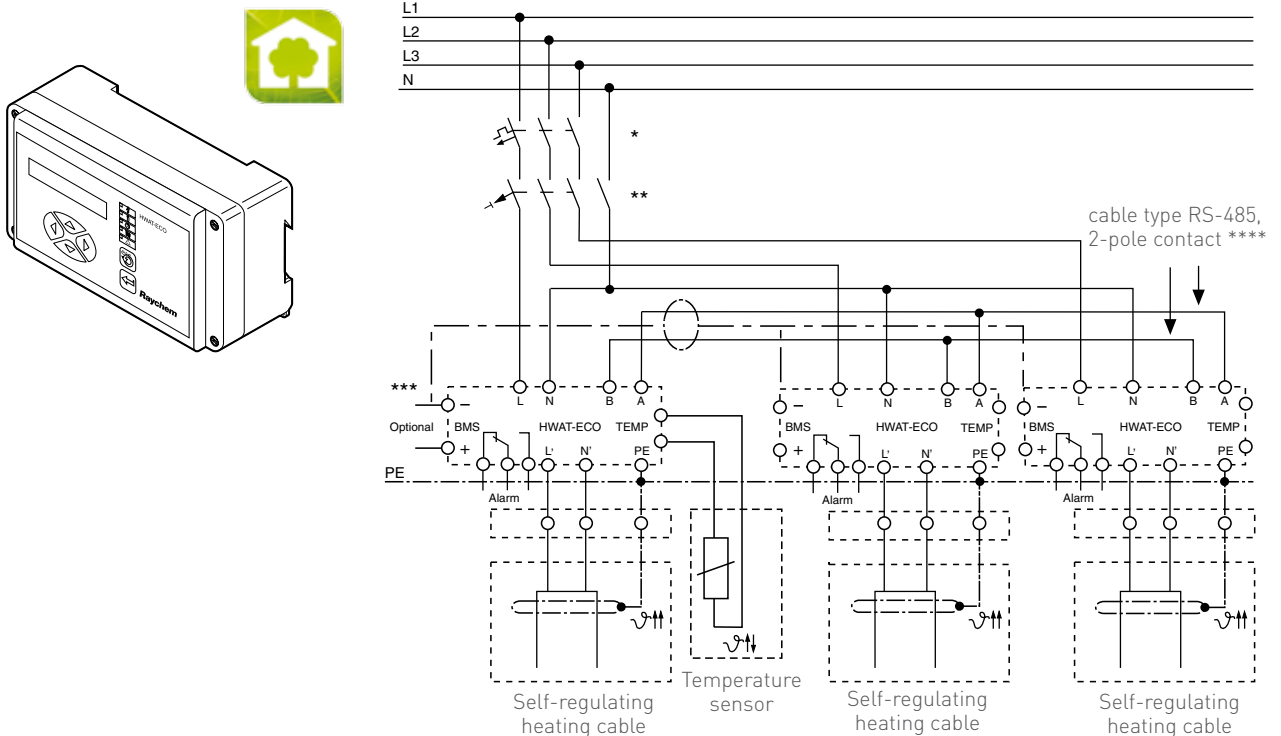

- * Two- or four-pole electrical protection by circuit breaker may be needed for local circumstances, standards and regulations
- ** Depending on the application, one- or three-pole circuit-breakers or contactors may be used
- *** Optional: Potential-free circuit-breaker for connection to the BMS
- **** The earth wire of shielded RS-485 cable needs to be connected to the BMS (-) terminal of each HWAT-ECO in the Master / Slave network.

HOT WATER TEMPERATURE MAINTENANCE

12 INSTALLATION INSTRUCTIONS FOR HWAT-L/M/R CABLES

- The heating cable should be installed in a straight line on the pipework.
- Install on dry surfaces
- Minimum installation temperature: -10°C

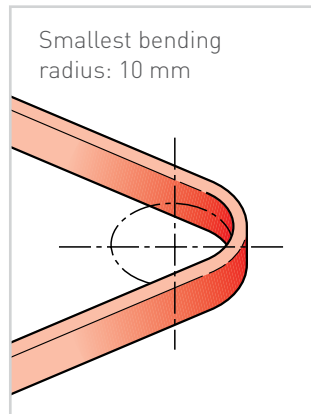
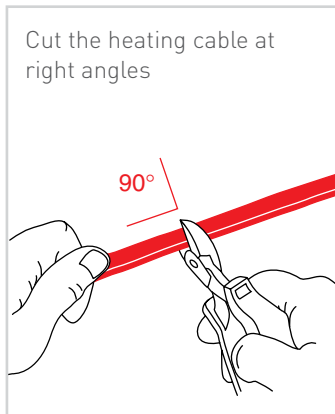
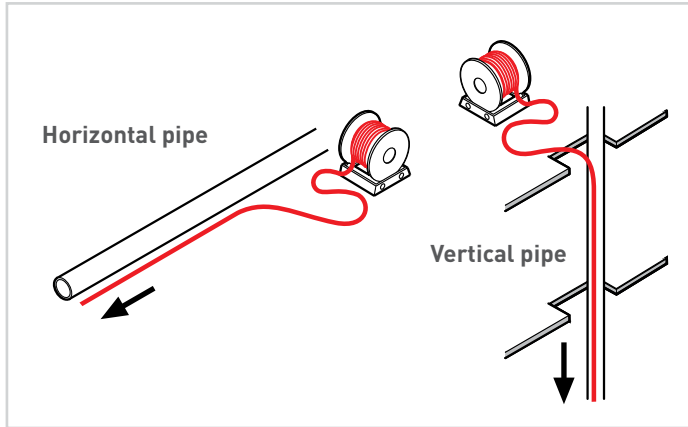

Installation of self-regulating heating cables

- Store in a dry and clean place.
- Temperature range: -40°C to $+60^{\circ}\text{C}$.
- Protect any cable ends with an end seal.

Avoid:

- sharp edges
- high tractive force
- kinking and crushing
- walking or driving over the cable
- moisture at cable interfaces

max. 300 mm

ca. 45° ca. 45°

horizontal pipes

Cable tie KBL-10

For plastic pipes use aluminium adhesive tape ATE-180. Place it over the entire length of the pipe

GT-66 / GS-54 adhesive tape

It is not necessary to spiral the cable around the pipe

Install the heating cables on the outside of the pipe bend

Wall/Floor transit

The thickness of thermal insulation must be continuous otherwise compensate by adding heating cable.

Standard Installation of PT100 Sensor with in-pipe sensor probe.

